

USER MANUAL

ATT 300 and ATE 300 displays configuration

New



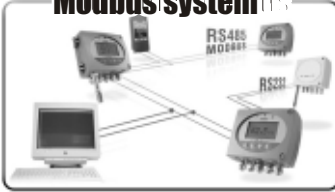

CE

Modbus system



Remote control



1. Prerequisite	P 1
1.a - Working principle	P 1
1.b - Output signal selection	P 2
2. Modbus parameters	P 3
2.a - Configuration parameters	P 3
2.b - Modbus functions	P 3
2.c - Register access security key	P 3
3. Activation code and access to functions	P 5
4. Display configuration •  F100	P 6
4.a - Transmitter channel for infrared remote control	P 6
4.b - Serial number of the instrument	P 7
4.c - Slave addressing (Modbus)	P 8
5. Unit of measurement selection •  F200	P 8
5.a - Preprogrammed units of measurement	P 8
5.b - Creation of a new unit of measurement	P 9
6. Channels and analogue input configuration •  F100 et  F300	P 10
6.a - Input type selection (analogue or digital)	P 10
6.b - Activation / deactivation of a channel	P 12
6.c - Comma position	P 12
6.d - Minimum and maximum settings of analogue input	P 13
6.e - LED meaning	P 14
7. Modbus communication speed •  F100	P 15
8. Error codes	P 15

1.a - Working principle

Class 300 display configuration can be made with the remote control and the Modbus system and enables you to configure the analogue inputs, activate the channels...

Principle: the configuration options are accessed via **folders and sub-folders** (similar to Windows®). Access is made via a **numerical code** (full details in this manual).

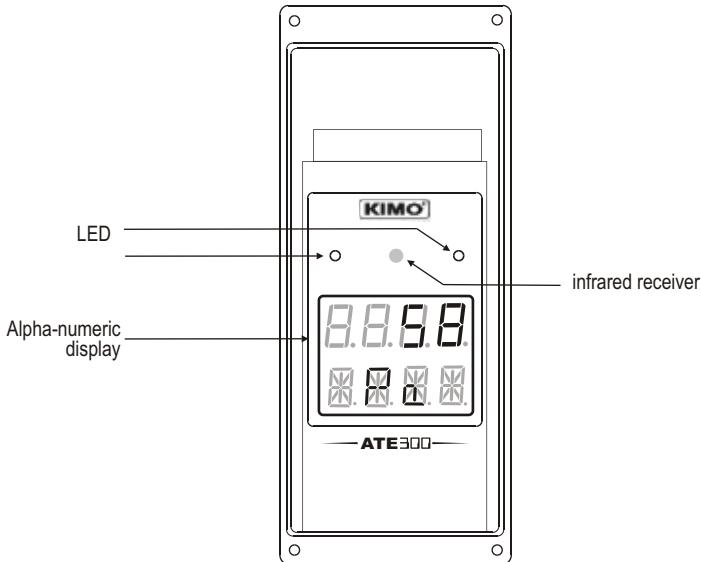
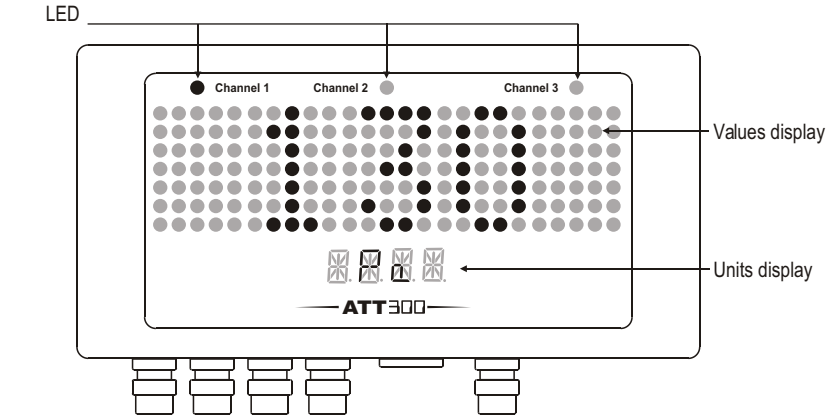



■ Meaning of remote control keys

- ⊕ To incremente a value or a level
- ⊖ To decremente a value or a level
- OK To validate an input
- Esc To cancel an input or to return to the previous step

Channel selector

With this selector, you can swap the transmission channel so that it matches with the transmitter reception channel. See page 6 to configure the transmitter reception channel.

NOTE

The preview screens were made from the ATE 300. But the principle **remains the same** for the ATT 300 configuration.

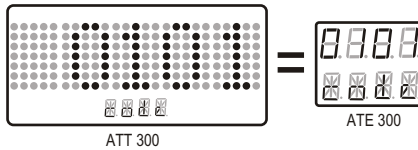

1.b -Input signal selection

Class 300 displays can output either a **voltage** or a **current** signal (see page 10)

ATT 300

With the orange on-off switch located between the terminal blocks (when the display is open), you can choose analogue output 0-10V (voltage) or 4-20 mA (current)

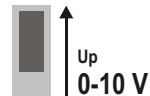
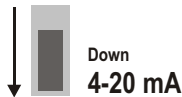

ATE 300

With the black on-off switch located on the left side of the display, you can choose the analogue input 0-10V (voltage) or 4-20 mA (current)

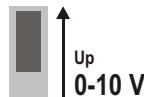
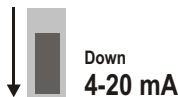

2.a - Configuration parameters

- Communication speed 19200 Bauds
- Data bits 8 bits
- Stop bit 1 bit
- Parity None
- Flow control None
- Transmitter addressing between 1 and 32
 (default address "0" for single ended bus configuration)
 To change the transmitter addressing, see page 7.

2.b - Functions

- Register reading Function 03
- Register writing Function 16
- Communication loop test Function 08

2.c - Access codes to Registers

- Registers type Signed long integer (32 bits), permuted (LSB, MSB)

- Values - Modbus code: **1438 (channel 1)**
 1442 (channel 2)
 1446 (channel 3)
 Ex. The value sent by the transmitter is 623

- Values formatting
 Modbus code: **1440 (channel 1)**
 1444 (channel 2)
 1448 (channel 3)

Units of measurement			
1	m/s	12	mmH ₂ O
2	fpm	13	inWg
3	m3/h	14	Kpa
4	L/s	15	mmHg
5	cfm	16	mbar
6	m3/s	17	g/kg (absolute humid. ρ)
7	°C	18	°C (dew temperature Td)
8	°F	19	°F (dew temperature Td)
9	%RH	20	°C (humid temp. Tw)
10	PSI	21	°F (humid temp. Tw)
11	Pa	22	KJ/Kg (Enthalpy i)

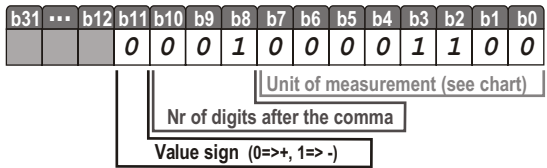

The formatting displayed is **268**.
 Unit of measurement => 12 (see chart)
 Figure(s) after the comma => 1
 Sign => positive

If the value measured is equal to 623 :
Result => 62,3 mmH₂O

NOTE

Other access codes to different registers are indicated on each function at stage n°2. Shown as this pictogram:



4.a - Canal du capteur pour la télécommande infrarouge

Vous pouvez régler le canal de télécommande infrarouge pour le télé-contrôle de votre pompe à eau.

Il y a 4 canaux différents du canal de télécommande.

Étape 1 F. 100

Entrez le mode de réglage de la page 2, appuyez sur le bouton de navigation, puis appuyez sur la touche de réglage de la page 1.

Étape 2 F. 100
00

Appuyez sur la touche de navigation (←) et sur la touche de réglage de la page 2. Entrez le mode de réglage de la page 2, appuyez sur la touche de réglage de la page 1.

Étape 3 02

Appuyez sur la touche de navigation (←) et sur la touche de réglage de la page 2. Entrez le mode de réglage de la page 3, appuyez sur la touche de réglage de la page 1.

Étape 4 02

Appuyez sur la touche de navigation (←) et sur la touche de réglage de la page 2. Entrez le mode de réglage de la page 4, appuyez sur la touche de réglage de la page 1. Entrez le mode de réglage de la page 4, appuyez sur la touche de réglage de la page 1.

3. Activation code and access to functions



This step is **COMPULSORY** for each configuration.

To access the transmitter functions, **and for safety**, you have to first enter a safety code.

- Please check that the transmitter is powered on.
- If the transmitter displays an error code, please see “Errors Code” section on page 13.

Step 1

Press **OK**

to get this screen

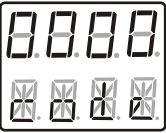

Step 2

Enter CODE “0101”

with keypad and
validate with **OK**

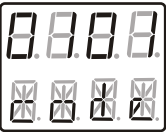

Step 3

This screen appears:

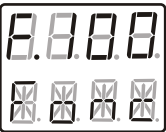

Step 4

Selection of
configuration folder

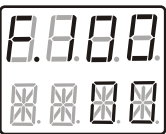

The first “0” blinks, which means that this column is activated and you can enter data from the keypad.



The code must be entered from left to right.

To **increment** a value or a level, press **+**

To **decrement** a value or a level, press **-**

To **validate a value (level) or to validate the code**, press **OK**

To return to the **previous status or to cancel**, press **Esc**

This screen confirms that the code was correctly entered, and that you can **configure the transmitter**.



If the code was wrongly entered, the transmitter initializes and returns to the starting display.



Configuration folder number

The transmitter includes **3 folders** maximum::

- 100
- 200
- 300

Ex. folder “200” corresponds to configuration of units of measurement. See page 12.



To select your configuration folder, press **+** to increment 100 or press **-** to decrement 100.

Once the folder is selected, press **OK** to validate.



On the top left of each page of this manual, you can find a reminder of the configuration folder where the function is available.

F400

4.a - Transmitter channel for infrared remote control



You can change the channel number for receiving the signal from the infrared remote control.

NOTE By default, the channel number is **0**.



Go into the configuration mode (see page 5). The folder number displayed corresponds to the last configuration folder used.



Select the folder "100" and validate with **OK**.



Select the sub-folder "100" and validate with **OK**.
The cursor > goes to the line of available choices.



With **+** and **-** keys, select the channel number (from **00** to **09**). Validate with **OK**.



The cursor > returns to sub-folders line.

- press twice **Esc** to return to reading mode
- press once **Esc** to select another folder.
- with **+** and **-** keys, you can choose another sub-folder from the folder 100.

4.b- Serial number of the transmitter



Go into configuration mode (see page 5). The folder number displayed corresponds to the last configuration folder used.



Select the folder "100" and validate with **OK**.



Select the sub-folder "101"



The serial number of the transmitter is displayed (on 2 lines on ATE300 and in horizontal scrolling on ATT300).

The cursor > goes to sub-folders line.

- press twice **Esc** to return to reading mode.
- press once **Esc** to return to another folder selection.
- with **+** and **-** keys to choose another sub-folder from the folder 100.

4.c - Slave addressing (Modbus)

Step
1



Go into configuration mode (see page 5). The folder number displayed corresponds to the last configuration folder used.

Step
2

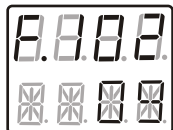

Select the folder "100" and validate with .



Select the sub-folder "106" and validate with .

The cursor > goes to available choices.



Step
3



With  and  keys, set the slave addressing number (from 1 to 32).

Validate with .

Step
4



The cursor > goes to sub-folders line.

- press twice  to return to reading mode.

- press once  to return to another folder selection.

- with  and  keys to choose another sub-folder from the folder 100.

5.a - Pre-programmed units of measurement

21 units are preprogrammed in the display, according to several parameters: pressure, temperature, humidity, air velocity and airflow...

Step 1



Go into configuration mode (see page 5). The folder number displayed corresponds to the last configuration folder used.

Step 2

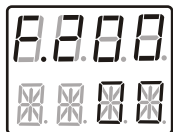

Select the folder "200" and validate with **OK**.

Select sub-folder

and validate with **OK**. The cursor > goes to choices line.

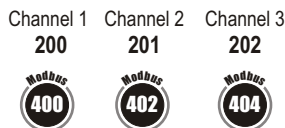

Step 3



With **+** and **-** keys, select the unit of measurement (see chart below). Validate with **OK**.

Units of measurement			
0	m/s	11	mmH ₂ O
1	fpm	12	inWg
2	m ³ /h	13	Kpa
3	L/s	14	mmHg
4	cfm	15	mbar
5	m ³ /s	16	g/kg (absolute humid. p)
6	°C	17	°C (dew temperature Td)
7	°F	18	°F (dew temperature Td)
8	%HR	19	°C (humid temp. Tw)
9	PSI	20	°F (humid temp. Tw)
10	Pa	21	KJ/Kg (Enthalpy i)

22 => free unit - see Page xxx

Step 4



The cursor > returns to sub-folders line.

- press twice **ESC** to return to reading mode.
- press once **ESC** to return to another folder selection.
- with **+** and **-** keys to choose another sub-folder from the folder 200.

5.b - Creation of a new unit of measurement

If the unit of measurement of the analogue input is not indicated in the preprogrammed units, this function enables you to create a new unit for each channel.

Step 1



Go into configuration mode (see page 5). The folder number displayed corresponds to the last configuration folder used.

Step 2

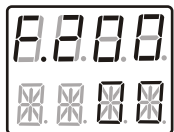

Select the folder "200" and validate with \ominus .

Selectionner sub-folder and validate with \odot . The cursor $\>$ goes to choices line.



Step 3



With \oplus and \ominus keys, select 22. Validate with \odot .

You enter in "Issue a new unit of measurement" mode.

NOTE the new unit of measurement has maximum 4 digits.

1 • By default, no digit segment will be activated. The first segment (on the first digit top) blinks.

2 • Meaning of the remote control keys

\oplus Goes to the next segment

\ominus Returns to the previous segment

\odot Activates the segment chosen (if it was not activated) or deactivates it (if it was activated). Then goes to next segment.

Esc Goes to next digit or validate a new unit if the fourth digit is selected.

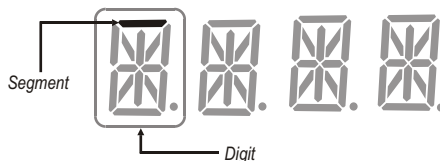

3 • Segments sequence

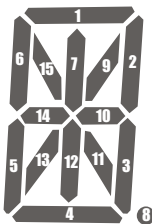

Step 4



Once the new unit is created, select the fourth digit and validate with Esc . The cursor $\>$ goes to sub-folders line.

- press twice Esc to return to reading mode.
- press once Esc to return to another folder selection.
- with \oplus and \ominus keys to choose another sub-folder from the folder 200.

6.a - Selection of input type

ATT 300 and ATE 300 have 3 analogue inputs (0-10V or 4-20mA), 1 digital input Rs232 type and one digital input RS485 type (Modbus system). Therefore, 2 different inputs are available: **analogue input or digital input**.

2 configuration types::

1-Display of values of a measuring system via Analogue inputs and Rs232

- Analogue input 0-10V / 4-20mA
- Rs485 digital input
- Rs232 digital input

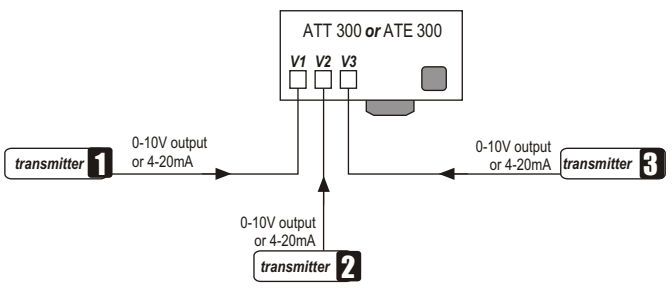

OR

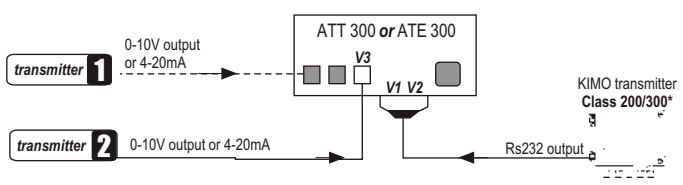

NOTE When you connect a Class 200/300 transmitter via Rs232, you can choose between **2 solutions of connection**, via the analogue inputs:

- 1> class 200/300 transmitter sends **2 values** = **1 analogue input** 0-10V / 4-20mA available (**Channel 3**)
- 2> class 200/300 sends **1 value** = **2 analogue inputs** 0-10 / 4-20mA available (**Channel 3 + Channel 1** or Channel 2, according to the Class 200/300 transmitter configuration. See user manual of Class 200).

! If you want to use the analogue inputs, you have to first **put the DIP switch** so that it matches with the input signal required (see page 2)

6.a - Selection of input type

2- Display of values of a measuring system via **Digital input**

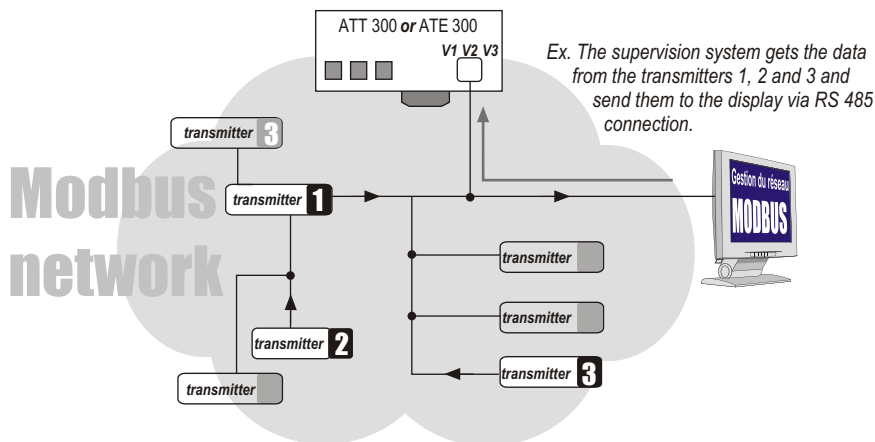

Step
1



Go into configuration mode (see page 5). The folder number displayed corresponds to the last configuration folder used.

Step
2



Select folder "104" and validate with



Step
3



With keys and , select **00** to **activate the analogue inputs and the RS 232** or **01** to **activate the RS485 digital input** (then, the analogue inputs and RS 232 are automatically deactivated).

Validate with .

Step
4



The cursor returns to sub-folders line.

- press twice to return to reading mode.
- press once to return to another folder selection.
- with and keys to choose another sub-folder from the folder 400.

6.b - Activation / Deactivation of a channel

Step 1



Go into configuration mode (see page 5). The folder number displayed corresponds to the last configuration folder used.

Step 2

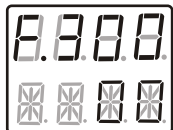

Select folder "300" and validate with **OK**.

Select sub-folder

and validate with **OK**. The cursor goes to the line of choices.



Step 3



With keys **+** and **-**, select **01** to **activate** the channel or **00** to **deactivate** it. Validate with **OK**.

Step 4



The cursor **>** returns to sub-folders line.

- press twice **Esc** to return to reading mode.
- press once **Esc** to return to another folder selection.
- with **+** and **-** keys to choose another sub-folder from the folder 400.

6.c - Comma position

Step 1



Go into configuration mode (see page 5). The folder number displayed corresponds to the last configuration folder used.

Step 2



Select subfolder "300" and validate with **OK**.

Select sub-folder

and validate with **OK**. The cursor goes to the line of choices available.

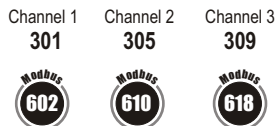

Step 3



With keys **+** and **-**, select

		ATT 300	ATE300
00	No comma	✓	✓
01	1 figure after the comma	✓	✓
02	2 figures after the comma	✓	✓
03	3 figures after the comma	✓	✗

Ex. : Value of the channel : 745

00 => 745

01 => 74,5

02 => 7,45

03 => 0,745 (ATT300)

Step 4



The cursor **>** returns to sub-folders line.

- press twice **Esc** to return to reading mode.
- press once **Esc** to return to another folder selection.
- with **+** and **-** keys to choose another sub-folder from the folder 400.

6.d - Minimum and maximum settings of analogue input

With this function, you can enter mini and maxi values of analogue input, so that they correspond to the limits of analogue signal (0-10V or 4-20mA).

1> Output minimum



Go into configuration mode (see page 5). The folder number displayed corresponds to the last configuration folder used.



Select folder "300" and validate with \odot .

Select sub-folder and validate with \odot . The cursor goes to the line of choices.

Channel 1	Channel 2	Channel 3
302	306	310
Modbus 604	Modbus 612	Modbus 620



With keys \oplus and \ominus , enter the value of the minimum limit. Validate with \odot .
Nota : the left column can be either an integer (from 0 to 9) or the negative sign for a negative minimum limit.



The cursor > returns to sub-folders line.

- press twice Esc to return to reading mode.
- press once Esc to return to another folder selection.
- with \oplus and \ominus keys to choose another sub-folder from the folder 400.

2> Output maximum



Go into configuration mode (see page 5). The folder number displayed corresponds to the last configuration folder used.



Select folder "300" and validate with \odot .

Select sub-folder and validate with \odot . The cursor goes to the line of choices.

Channel 1	Channel 2	Channel 3
303	307	311
Modbus 606	Modbus 614	Modbus 622



With keys \oplus and \ominus , enter the value of the minimum limit. Validate with \odot .
Nota : the left column can be either an integer (from 0 to 9) or the negative sign for a negative minimum limit.



The cursor > returns to sub-folders line.

- press twice Esc to return to reading mode.
- press once Esc to return to another folder selection.
- with \oplus and \ominus keys to choose another sub-folder from the folder 400.

6.e - Meaning of alarms and color LED

6.e.1 - ATT 300

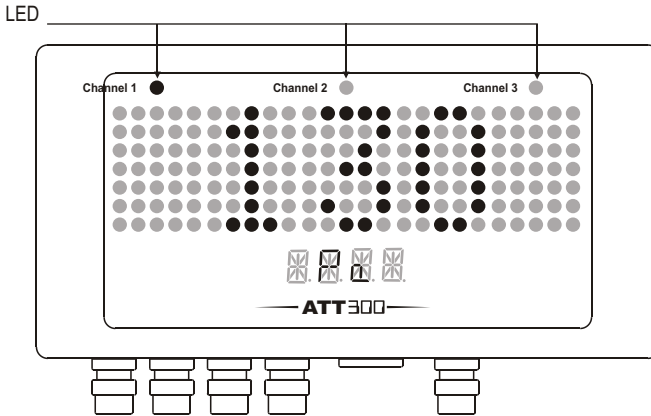

The **3 LED** correspond to the channels.

The channel value (displayed by ATT 300) is automatically linked to a LED.

Ex. LED of channel 1 is activated and its value is 130 Pa.

6.e.2 - ATE 300

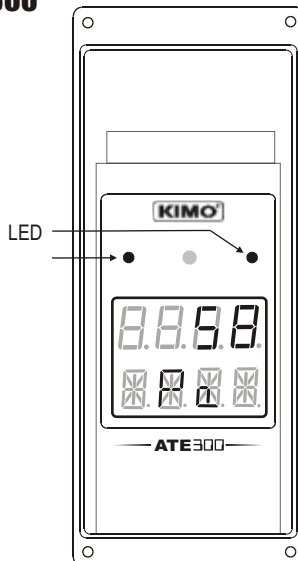

The channels are represented by **2 LED**. The channel value (displayed by ATE 300) is automatically linked to 2 LED.

The 2 different channels are identified with a colour code:

2 **green** LED : channel 1

2 **orange** LED : channel 2

2 **red** LED : channel 3



7. Modbus communication speed

Step
1



Go into configuration mode (see page 5). The folder number displayed corresponds to the last configuration folder used.

Step
2



Select folder "100" and validate with **OK**.
Select sub-folder "103" and validate with **OK**.

Step
3



With keys **+** and **-**, select a communication speed (see chart below). Validate with **OK**.



00	2400 bauds	03	19200 bauds (speed by default)
01	4800 bauds	04	38400 bauds
02	9600 bauds	05	115200 bauds

Step
4



The cursor **>** returns to sub-folders line.
• press twice **Esc** to return to reading mode.
• press once **Esc** to return to another folder selection.
• with **+** and **-** keys to choose another sub-folder from the folder 100

10. Error codes

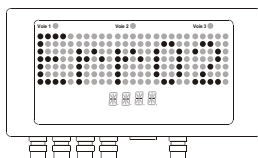

Error code 2

Problem :

- No channel activated

Solution :

- Activate at least one channel



Code		Description	Available settings												
100	200	Channel number of the remote control	0 to 9												
101	202	Serial number reading													
102	204	Modbus slave number	1 to 32												
103	206	Modbus communication speed	<table border="1"> <tr> <td>00</td> <td>2400 bds</td> <td>02</td> <td>9600 bds</td> <td>04</td> <td>38400 bds</td> </tr> <tr> <td>01</td> <td>4800 bds</td> <td>03</td> <td>19200 bds</td> <td>05</td> <td>115200 bds</td> </tr> </table>	00	2400 bds	02	9600 bds	04	38400 bds	01	4800 bds	03	19200 bds	05	115200 bds
00	2400 bds	02	9600 bds	04	38400 bds										
01	4800 bds	03	19200 bds	05	115200 bds										
104	208	Input type selection													



Code		Description	Available settings																																																
200	400	Unit of channel 1	<table border="1"> <thead> <tr> <th colspan="4">Units of measurement</th> </tr> </thead> <tbody> <tr> <td>0</td> <td>m/s</td> <td>11</td> <td>mmH₂O</td> </tr> <tr> <td>1</td> <td>fpm</td> <td>12</td> <td>inWg</td> </tr> <tr> <td>2</td> <td>m3/h</td> <td>13</td> <td>Kpa</td> </tr> <tr> <td>3</td> <td>L/s</td> <td>14</td> <td>mmHg</td> </tr> <tr> <td>4</td> <td>cfm</td> <td>15</td> <td>mbar</td> </tr> <tr> <td>5</td> <td>m3/s</td> <td>16</td> <td>g/kg (absolute humid.p)</td> </tr> <tr> <td>6</td> <td>°C</td> <td>17</td> <td>°C (dew temp. Td)</td> </tr> <tr> <td>7</td> <td>°F</td> <td>18</td> <td>°F (dew temp. Td)</td> </tr> <tr> <td>8</td> <td>%HR</td> <td>19</td> <td>°C (humid temp. Tw)</td> </tr> <tr> <td>9</td> <td>PSI</td> <td>20</td> <td>°F (humid temp. Tw)</td> </tr> <tr> <td>10</td> <td>Pa</td> <td>21</td> <td>KJ/Kg (Enthalpy i)</td> </tr> </tbody> </table>	Units of measurement				0	m/s	11	mmH ₂ O	1	fpm	12	inWg	2	m3/h	13	Kpa	3	L/s	14	mmHg	4	cfm	15	mbar	5	m3/s	16	g/kg (absolute humid.p)	6	°C	17	°C (dew temp. Td)	7	°F	18	°F (dew temp. Td)	8	%HR	19	°C (humid temp. Tw)	9	PSI	20	°F (humid temp. Tw)	10	Pa	21	KJ/Kg (Enthalpy i)
Units of measurement																																																			
0	m/s	11		mmH ₂ O																																															
1	fpm	12	inWg																																																
2	m3/h	13	Kpa																																																
3	L/s	14	mmHg																																																
4	cfm	15	mbar																																																
5	m3/s	16	g/kg (absolute humid.p)																																																
6	°C	17	°C (dew temp. Td)																																																
7	°F	18	°F (dew temp. Td)																																																
8	%HR	19	°C (humid temp. Tw)																																																
9	PSI	20	°F (humid temp. Tw)																																																
10	Pa	21	KJ/Kg (Enthalpy i)																																																
201	402	Unit of channel 2																																																	
202	404	Unit of channel 3																																																	

22 => Free unit - see Page 9



Code	 Description	Available settings
<i>300</i>	600 Activation / Deactivation of channel 1	0 or 1
<i>301</i>	602 Position of the comma of channel 1	
<i>302</i>	604 Minimum of analogue input of channel 1	
<i>303</i>	606 Maximum of analogue input of channel 1	
<i>304</i>	608 Activation / Deactivation of channel 2	0 or 1
<i>305</i>	610 Position of the comma of channel 2	
<i>306</i>	612 Minimum of analogue input of channel 2	
<i>307</i>	614 Maximum of analogue input of channel 2	
<i>308</i>	616 Activation / Deactivation of channel 3	0 or 1
<i>309</i>	618 Position of the comma of channel 3	
<i>310</i>	620 Minimum of analogue input of channel 3	
<i>311</i>	622 Maximum of analogue input of channel 3	

www.kimo.fr

EXPORT DEPART MENT

Boulevard de Beaubourg

Emerainville - BP 48

77312 MARNELA VALLEE CEDEX 2

Tel : + 33.1.60.06.69.25

Fax : + 33.1.60.06.69.29

