

USER MANUAL

New

CE

Configuration of Class 300 Transmitters

Keypad



Remote control



Modbus network

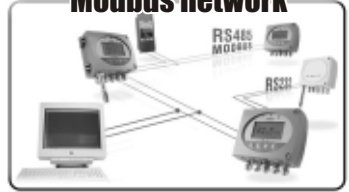

Pressure
< CP300



Temperature
Humidity

TH300 >
Remote probe



< TH300
Standard probe





1. Prerequisite	P 1
1.a - Working principle	P 1
1.b - Output signal selection	P 1
2. Modbus parameters	P 3
2.a - Configuration parameters	P 3
2.b - Modbus functions	P 3
2.c - Register access security key	P 3
3. Activation code and access to functions	P 5
4. Display and keypad configuration • F100	P 6
4.a - Transmitter channel for infrared remote control	P 6
4.b - Backlight	P 6
4.c - Display contrast control	P 7
4.d - Keypad locking	P 7
4.e - Slave addressing (Modbus)	P 8
5. Configuring channels and units of measurement • F200	P 9
6. Analogue output management • F300	P 10
6.a - Output diagnostics	P 11
6.b - Analogue outputs setting	P 12
7. Alarm / Relay settings • F400	P 14
7.a - Activation / Deactivation of BEEP alarm	P 14
7.b - Relay security	P 14
7.c - Alarm / relay functions and LED colour codes	P 15
7.d - Channel selection for alarms / relays	P 16
7.e - Alarm mode details	P 17
7.f - Alarm mode selection	P 19
7.g - Set points and time-delay setting	P 20
8. Pressure measurement configuration • F500	P 22
8.a - Pressure measurement integration (CP 300)	P 22
8.b - Time-delay between 2 self-calibrations (CP 300)	P 22
9. Humidity measurement configuration • F500	P 23
9.a - Humidity and temperature offset adjustment (TH 300)	P 23
10. Air velocity measurement configuration (CP300 + SQR) • F600	P 24
10.a - Temperature compensation	P 24
10.b - Air velocity coefficient selection	P 26
10.c - Air velocity correction coefficient input	P 27

12.a - Activation / Deactivation of the RS 232 and home bus	P 31
12.b - Serial number display	P 31
12.c - Modification of Modbus communication speed	P 32
12.d - Purge Mode	P 33
13. Error codes	P 35
14. Functions recap	P 37



1.a - Working principle

Using keypad / remote control / Modbus configuration, you can activate (or deactivate) a channel, change the measuring range, set the set points and time-delay...



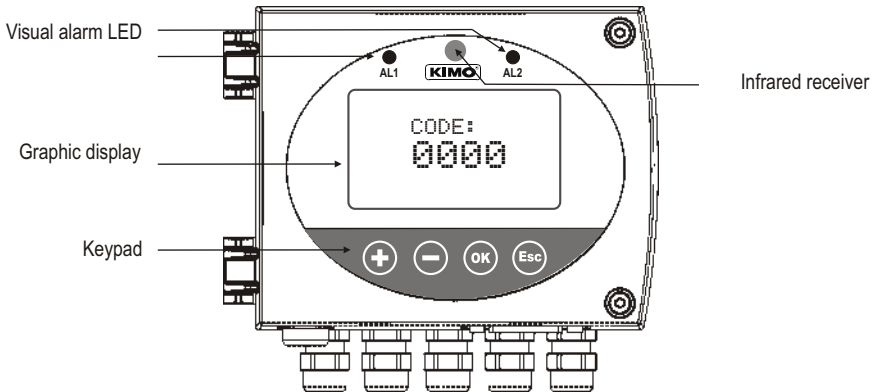

Principle: the configuration options are accessed via **folders and sub-folders** (similar to Windows[®]). Access is made via a **numerical code** (full details in this manual).

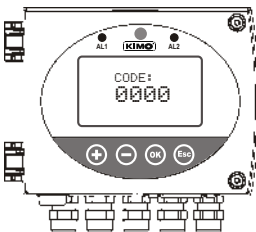

1.a.1 - Keypad



■ Meaning of the keys

-  To increment a value or a level
-  To decrement a value or a level
-  To validate an input
-  To cancel an input or to return to the previous step



1.a.2 - Infrared remote control



The remote control works like the keypad and the **configuration method remains exactly the same** whichever you use (keypad or remote control).



■ Meaning of the remote control keys

- ⊕ To increment a value or a level
- ⊖ To decrement a value or a level
- OK To validate an input
- Esc To cancel an input or to return to the previous step

Channel selector

With this selector, you can swap the transmission channel so that it matches with the transmitter reception channel. See page 6 to configure the transmitter reception channel.

1.b - Output signal selection

Voltage or Current ?

The Class 300 can output either a **voltage** or a **current** signal.

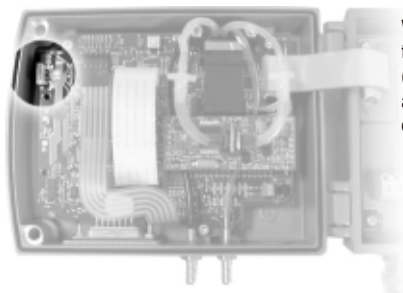

With the on-off switch located on the left top of the transmitter (when open), you can choose analogue output 0-10V (voltage) or 4-20 mA (current)



Down
0-10 V

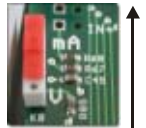

Up
4-20 mA



2.a - Configuration parameters

- **Communication speed** 19200 Bauds (see page 33 to configure the speed)
- **Data bits** 8 bits
- **Stop bit** 1 bit
- **Parity** None
- **Flow control** None
- **Transmitter addressing** between 1 and 32
default address "0" for single ended bus configuration

2.b - Functions

- **Register reading** Function 03
- **Register writing** Function 16
- **Communication loop test** Function 08

2.c - Access codes to Registers

- **Registers type** Signed long integer (32 bits), permuted (LSB, MSB)

- **Alarms status** - Modbus code : **1436**

*Ex. The value sent by the transmitter is 5
Alarm condition 1
and relay 1 excited*

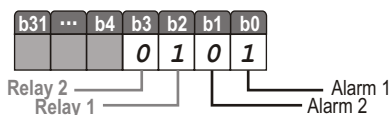

- **Values** - Modbus code : **1438 (channel 1)**
1442 (channel 2)
1446 (channel 3 or value 1 of the external transmitter)
1450 (channel 4 or value 2 of the external transmitter)
Ex. the value sent by the transmitter is 6321

- **Values formatting** - Modbus code : **1440 (channel 1)**
1444 (channel 2)
1448 (channel 3 or value 1 of the external transmitter)
1452 (channel 4 or value 2 of the external transmitter)

Units of measurement			
1	m/s	12	mmH ₂ O
2	fpm	13	inWg
3	m ³ /h	14	Kpa
4	L/s	15	mmHg
5	cfm	16	mbar
6	m ³ /s	17	g/kg (absolute humidity. p)
7	°C	18	°C (dew temp. Td)
8	°F	19	°F (dew temp. Td)
9	%RH	20	°C (wet temp. Tw)
10	PSI	21	°F (wet temp. Tw)
11	Pa	22	KJ/Kg (Enthalpy i)

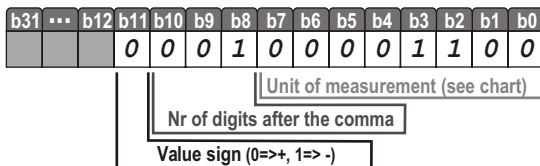

*Ex. The formatting displayed is 268.
Unit of measurement => 12 (see chart)
Figure(s) after the comma => 1
Sign => positive*

*If the value measured is equal to 6231 :
Result => 623,1 mmH₂O*



2.c - Access code to Registers (sequel)

- Serial number of sensing element (SPI - CP300 / Humidity - TH300)

Modbus code: 1402

NOTE

Other access codes to different registers are indicated on each function at stage n°2.

Shown as this pictogram:



4.b - Backlight

With the backlight, the reading is easier, with more contrast. The ambient light is weak. You can activate or deactivate it.

STEP 1 Go into the configuration mode (see page 5). The folder number displayed corresponds to the last folder used.

STEP 2 Select the folder "100" and validate with . The cursor goes to the first available choice.

STEP 3 With and keys, select 0 to **deactivate** the backlight or 01 to **activate** the backlight.

STEP 4 The cursor returns to the top folder line.
 • press to return to reading mode.
 • press to select another folder.
 • with and keys, you can choose another sub folder from the folder 100.



3. Activation code and access to functions

! This step is COMPULSORY for each configuration.

To access the transmitter functions, **and for safety**, you have to first enter a safety code.

- Please check that the transmitter is powered on.
- If the transmitter displays an error code, please see “Errors Code” section on page 35

Step 1

Press on **OK** to get this screen



Step 2

Enter the CODE “0101” with the keypad and validate with **OK**



Step 3

This screen appears:



Step 4

Configuration folder selection

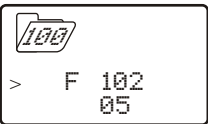

? The first “0” blinks, which means that this column is activated and you can enter data from the keypad.

? The code must be entered from left to right.

To **increment** a value or a level, press **+**

To **decrement** a value or a level, press **-**

To **validate a value (level) or to validate the code**, press **OK**

To return to the **previous status or to cancel**, press **Esc**

? This screen confirms that the code was correctly entered, and that you can **configure the transmitter**.

If the code was wrongly entered, the transmitter initializes and returns to the starting display.



Configuration folder number

The transmitter includes **6 folders** maximum::

- 100
- 200
- 300
- 400
- 500
- 600

Ex. In the folder 400, you can configure the alarms and relays. See page 14.

? To select your configuration folder, press **+** to increment 100 or press **-** to decrement 100.

Once the folder is selected, press **OK** to validate.



On the top left of each page of this manual, you can find a reminder of the configuration folder where the function is available.

F400

4.a - Transmitter channel for infrared remote control



You can change the channel number for receiving the signal from the infrared remote control.

The advantage is that only one remote control is required to drive several transmitters, and that there is no interference if 2 transmitters are located side by side.

NOTE By default, the channel number is **0**.



Go into the configuration mode (see page 5). The folder number displayed corresponds to the last configuration folder used.

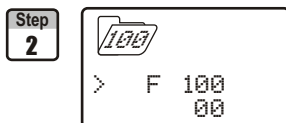

Select the folder "100" and validate with **OK**.

Select the sub-folder "100" and validate with **OK**.
The cursor > goes to the line of available choices.



With **+** and **-** keys, select the channel number (from 00 to 09). Validate with **OK**.



The cursor > returns to sub-folders line.

- press twice **Esc** to return to reading mode
- press once **Esc** to select another folder.
- with **+** and **-** keys, you can choose another sub-folder from the folder 100.

4.b - Backlight

With the backlight, the reading is easier with more contrast, if the ambient light is weak.

You can activate or deactivate it.



Go into the configuration mode (see page 5). The folder number displayed corresponds to the last folder used.

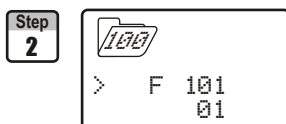

Select the folder "100" and validate with **OK**.

Select the sub-folder "101" and validate with **OK**.
The cursor > goes to the line of available choices.

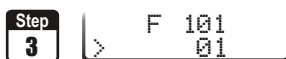



With **+** and **-** keys, select 00 to **deactivate** the backlit or 01 to **activate**.
Validate with **OK**.



The cursor > returns to sub-folders line.

- press twice **Esc** to return to reading mode.
- press once **Esc** to select another folder.
- with **+** and **-** keys, you can choose another sub-folder from the folder 100.

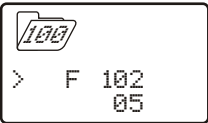
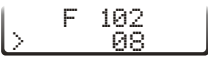
4.c - Display contrast control

- Step 1**  Go into configuration mode (see page 5). The folder number which appears corresponds to the last configuration folder used.
- Step 2**  Select the folder "100" and validate with **OK**.
Select the sub-folder "102" and validate with **OK**.
The cursor > goes to the line of available choices.
- Step 3**  With **+** and **-** keys, set the contrast required (from 0 to 10). Validate with **OK**.
- Step 4**  The cursor > returns to sub-folders line.
- press twice **ESC** to return to reading mode.
 - press once **ESC** to return to another folder selection.
 - with **+** and **-** keys, you can choose another sub-folder from folder 100.



4.d - Keypad locking

 For safety, you can lock the keypad access. Like on a mobile phone, the keys will be disabled after having been locked.

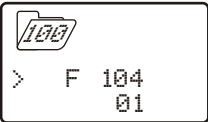
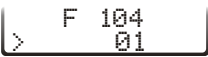
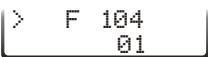
- Step 1**  Go into configuration mode (see page 5). The folder number which appears corresponds to the last folder used.
- Step 2**  Select the folder "100" and validate with **OK**.
Select the sub-folder "104" and validate **OK**.
The cursor > goes to the different choices available.
- Step 3**  With **+** and **-** keys, select **01** to **lock** the keypad access or **00** if you **do not want to lock the keypad**. Validate with **OK**.
- Step 4**  The cursor > returns to sub-folders line.
- press twice **ESC** to return to reading mode.
 - press once **ESC** to return to another folder selection.
 - with **+** and **-** keys to choose another sub-folder from the folder 100



To unlock keypad access, press and hold the **OK key for 10 seconds.**

After 10 seconds, an **audible signal** confirms that the keypad is unlocked.

4.e - Slave addressing (Modbus)

Step
1



Go into configuration mode (see page 5). The folder number displayed corresponds to the last configuration folder used.

Step
2

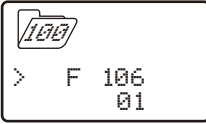

Select the folder "100" and validate with .



Select the sub-folder "106" and validate with .

The cursor > goes to available choices.

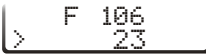

Step
3







With  and  keys, set the slave addressing number (from 1 to 32).

Validate with .

Step
4



The cursor > goes to sub-folders line.

- press twice  to return to reading mode.
- press once  to return to another folder selection.
- with  and  keys to choose another sub-folder from the folder 100.

**F200**

5. Configuring channels and units of measurement

Class 300 transmitters have 4 measuring channels. You can activate 1, 2, 3 or 4 channels and select each unit of measurement.

Step 1

Go into configuration mode (see page 5). The folder number displayed corresponds to the last configuration folder used.

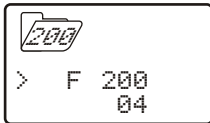
Step 2

Select the folder "200" and validate with \odot .

Select sub-folder and validate with \odot . The cursor > goes to choices line.

Channel 1

Channel 2

Channel 3

Channel 4

200**201****202****203**

Modbus

Modbus

Modbus

Modbus

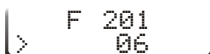
400**402****404****406****Step 3**

With \oplus and \ominus keys, select the unit of measurement (see chart below). Validate with \odot .

	CP301, 302 et 303	CP 304	TH300
00	Inactivated channel	Inactivated ch.	Inactivated channel
01	Pa	Pa	°C
02	mmH ₂ O	mmH ₂ O	°F
03	inWg	inWg	%RH
04	mbar	mbar	g/Kg (absolute humid. p)
05	°C	mmHg	°C (dew temperature Td)
06	°F	°C	°F (dew temperature Td)
07	m/s	°F	°C (wet temperature Tw)
08	fpm	m/s	°F (wet temperature Tw)
09	m ³ /h	fpm	KJ/Kg (Enthalpy I)
10	L/s	m ³ /h	
11	cfm	L/s	
12	m ³ /s	cfm	
13		m ³ /s	

NOTE

For a CP 300 transmitter (301, 302, 303 and 304), the **SQR option** is required in order to activate the units of air velocity and airflow.

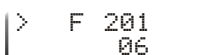
Step 4

The cursor > returns to sub-folders line.

- press twice Esc to return to reading mode.
- press once Esc to return to another folder selection.
- with \oplus and \ominus keys to choose another sub-folder from the folder 200.

6.a - Output diagnostics

With this function, you can check with a multimeter (or a regulator/display, or a PLC/BMS) if the transmitter outputs are working properly. The transmitter generates a voltage of 0 V, 5 V and 10 V or a current of 4 mA, 12 mA and 20 mA.

6.a.1 - Multimeter connection configuration

Before carrying out the output diagnostics, all connections and configurations of the transmitter must be enabled, to avoid any damage on the transmitter and the multimeter!

Step 1
Selection of the channel to be checked

First, **select a channel** for the output diagnostics.



The channel numbers are indicated on the board located below the terminal block.

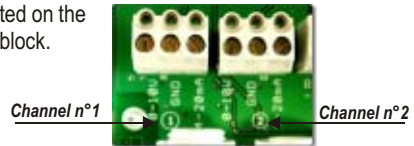

Step 2
Example of connection

On the photo alongside, the multimeter is connected to the 0-10 V output and channel n°1.

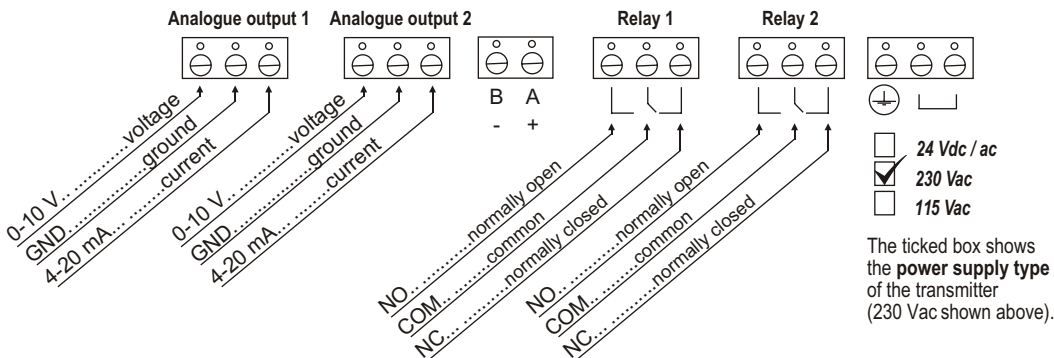
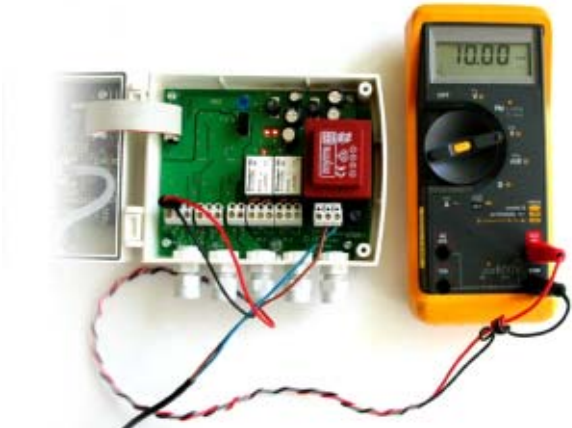

6.a.2 - Output diagnostics

Once the connection of the transmitter to the multimeter (or regulator or PLC/BMS is complete, (see page 6), you can carry out the analogue output diagnostics on several check points.



Go into configuration mode (see page 5). The folder number displayed corresponds to the last configuration folder used.

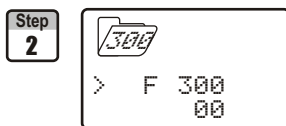

Select the folder "300" and validate with **OK**.

Channel n° 1 output

Select sub-folder "300"



Channel n° 2 output

Select sub-folder "303"



and validate with **OK**.

The cursor > goes to available choices.

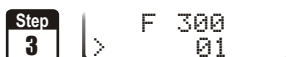

With **+** and **-** keys, select the signal that the transmitter must output (see chart below). Note : no need to validate with **OK**.



	<i>Diagnostic Output</i>
00	0 V
01	5 V
02	10 V
03	4 mA
04	12 mA
05	20 mA



If the deviations are too big (>0,05V or >0,05mA) between the signal issued and the value displayed on the multimeter, we recommend that you return the transmitter to our factory.



The cursor > returns to sub-folders line.

- press twice **ESC** to return to reading mode.
- press once **ESC** to return to another folder selection.
- with **+** and **-** keys to choose another sub-folder from the folder 300.

6.b - Analogue output settings

With this function, you can modify the measuring range of the transmitter, and you can equate the new limits to the analogue output (0-10V or 4-20mA).

You can enter the measuring range required on your own !



You must enter the values according to the units of measurement selected, not according to the measuring range of the transmitter.

*Eg. on a CP 303 pressure transmitter (0 to ± 1000 Pa) with a reading in mmH₂O, the minimum and maximum ranges must be configured on measuring range of 0 to ± 102 mmH₂O. See **conversion chart on following page**.*

Step 1



Go into configuration mode (see page 5). The folder number displayed corresponds to the last configuration folder used.

Step 2

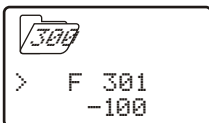

Select the folder "300" and validate with **OK**.

Minimum of Channel n°1
output



Minimum of Channel n°2
output



Select sub-folder "301"

Select sub-folder "304"

and validate with **OK**. The cursor > returns to the input line.

Step 3

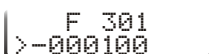

With **+** and **-** keys, select the value sign: negative or positive, validate with **OK**. Then, enter the minimum limit value and validate with **OK**.

Step 4



Maximum of Channel n°1
output



Maximum of Channel n°2
output



Select sub-folder "302"

Select sub-folder "305"

and validate with **OK**. The cursor > goes to the input line.

Step 5



With **+** and **-** keys, select the value sign: negative or positive, validate with **OK**.

Then, enter the maximum limit value and validate with **OK**.



We recommend that the interval between the minimum and maximum is **> 5% of the measuring range**.

Step 6

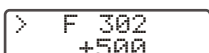

The cursor > goes to sub-folders line.

- press twice **ESC** to return to reading mode.
- press once **ESC** to return to another folder selection.
- with **+** and **-** keys you can choose another sub-folder from the folder 300.

NOTE

After an analogue output setting, if the unit of measurement is modified (see page 5), you have to reconfigure the outputs according to the new unit of measurement.

**6.b.1 - Units of measurement conversion chart****Pressure**



	<i>Pa</i>	<i>mmH2O</i>	<i>inWg</i>	<i>mbar</i>	<i>mmHg</i>
CP 301	0 to ±100	0 to ±10,2	0 to ±0,401	0 to ±1,00	-
CP 302	0 to ±500	0 to ±51,0	0 to ±2,005	0 to ±5,00	-
CP 303	0 to ±1000	0 to ±102,0	0 to ±4,015	0 to ±10,00	-
CP 304	0 to ±10000	0 to ±1020,0	0 to ±40,01	0 to ±100,00	0 to ±75,00

Temperature

	°C	°F
TH 300 - St. steel probe	-40,0 to +180,0	-40,0 to +356,0
TH 300 - PC probe	-20,0 to +80,0	-4,0 to +176,0

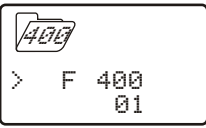

7.a - Activation / Deactivation of BEEP alarm

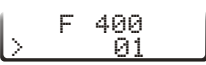
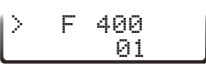
The beep alarm (audible alarm) is activated when a set point is reached.
For more details on the setpoint settings, see page 20.

- Step 1**  Go into configuration mode (page 5). The folder number displayed corresponds to the last configuration folder used.
- Step 2**  Select the folder "400" and validate with **OK**.
Select sub-folder "400" and validate with **OK**.
The cursor > goes to available choices. 
- Step 3**  With **+** and **-** keys, select **01** to **activate** the BEEP alarm or **00** to **deactivate**. Validate with **OK**.
- Step 4**  The cursor > goes to sub-folders line.
 - press twice **Esc** to return to reading mode.
 - press once **Esc** to return to another folder selection.
 - with **+** and **-** keys you can choose another sub-folder from the folder 400.

7.b - Relay security

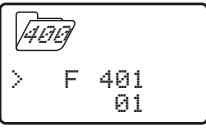
The relay outputs are by default, in **negative security**: the relay is **energized** when a set point is reached.
With the keypad, you can swap the relays in **positive security**: then, the relay is **de-energized** when a set point is reached or during a power outage.

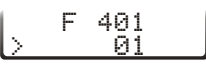
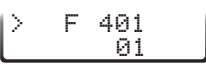
- Step 1**  Enter in configuration mode (see page 5). The folder number displayed corresponds to the last configuration folder used.
- Step 2**  Select folder "400" and validate with **OK**.
Select sub-folder "401" and validate with **OK**.
The cursor > goes to available choices. 
- Step 3**  With the keys **+** and **-**, select **01** for a **positive** security or **00** for a **negative** security. Validate with **OK**.
- Step 4**  The cursor > returns to sub-folders line.
 - press twice on **Esc** to return to reading mode.
 - press once on **Esc** to return to another folder selection.
 - with **+** and **-** keys, you can choose another sub-folder from the folder 400.

7.c - Alarm / relay functions and LED colour codes

7.c.1 - Visual / audible alarms

Class 300 transmitters have 2 visual / audible alarms located in front of the transmitter, allowing to know the condition of the setpoints.

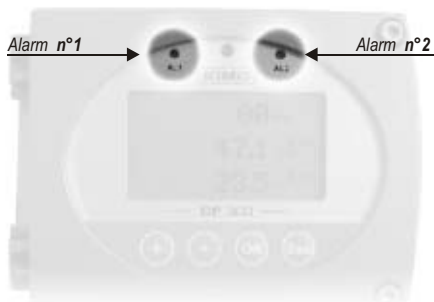

Alarm LED colour codes

- Green** The alarm function is activated and the set point is not reached
- Red** The alarm function is activated and the setpoint is reached
- None** The alarm function is **not activated**



The red LED appears when the setpoint is reached, taking into account the time-delay and the action type (falling or rising).
See page 17 for more details.

Audible alarm

Once the alarm is activated, an alarm sounds whilst the setpoint is reached.



The BEEP alarm function must be activated to use the audible alarm. See page 14.

7.c.2 - The relays

Class 300 transmitters have 2 relays visible on the transmitter board. These 2 relays each have one LED to allow **real-time checking**.

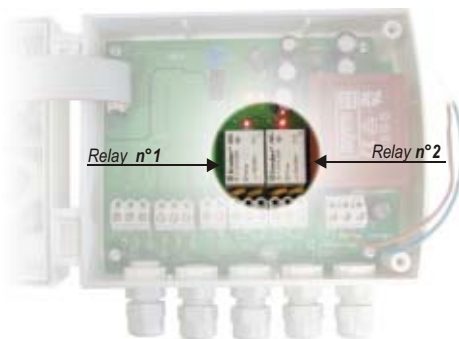

Relay LED colour codes

- Red** The relay is **energized**
- None** The relay is **not energized** or **has not been configured**



The relay is energized when the setpoint is reached, taking into account the time-delay, the action type and also the alarms security mode.
Set points, time-delay and action type setting: see page 20
Alarm security settings: see page 14

7.d - Selection of the channel for visual and relays alarms

Class 300 transmitters have 4 alarms: 2 visual (LED) and audible alarms and 2 relay alarms. The transmitter can be configured with 4 different alarms setups.



Before any alarm setup, check that the corresponding channel(s) is activated.

Step 1



Go into configuration mode (see page 5). The folder number displayed corresponds to the last configuration folder used.

Step 2

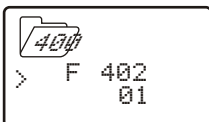

Select the folder "400" and validate with **OK**.

Select sub-folder

"402"



Alarm 1
(LED 1)

"407"



Alarm 2
(LED 2)

"412"



Relay 1

"417"



Relay 2

and validate with **OK**.

Step 3

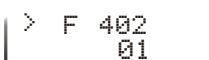

With **+** and **-** keys, select the channel number for which you want to configure an alarm. Validate with **OK**.

Step 4

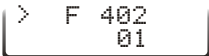

The cursor **>** returns to sub-folders line.

- press twice **Esc** to return to reading mode.
- press once **Esc** to return to another folder selection.
- with **+** and **-** keys, you can choose another sub-folder from the folder 400 (i.e. for example to configure another alarm / relay)

7.e - Alarm mode details

7.e.1 - Definitions

Setpoint

The setpoint is a limit which, on being reached and/or exceeded, activates an alarm or energizes a relay (in negative security, see page 14 for more details).

Time-delay

Once the setpoint is reached and/or exceeded, the time-delay postpones the alarm activation (or relay excitation) for a short period (in seconds). Once this period is elapsed, and if the setpoint is still exceeded, then the alarm is activated or the relay is energized (in negative security).

Action type

For alarm activation or relay excitation, you can choose the action type: rising or falling action.

- **Rising action:** the alarm is activated once the measurement **goes over** the setpoint
- **Falling action:** the alarm is activated once the measurement **goes below** the setpoint

7.e.2 - Available configurations

Configuration N°1 : 2 setpoints and time-delay activated (Control Mode)

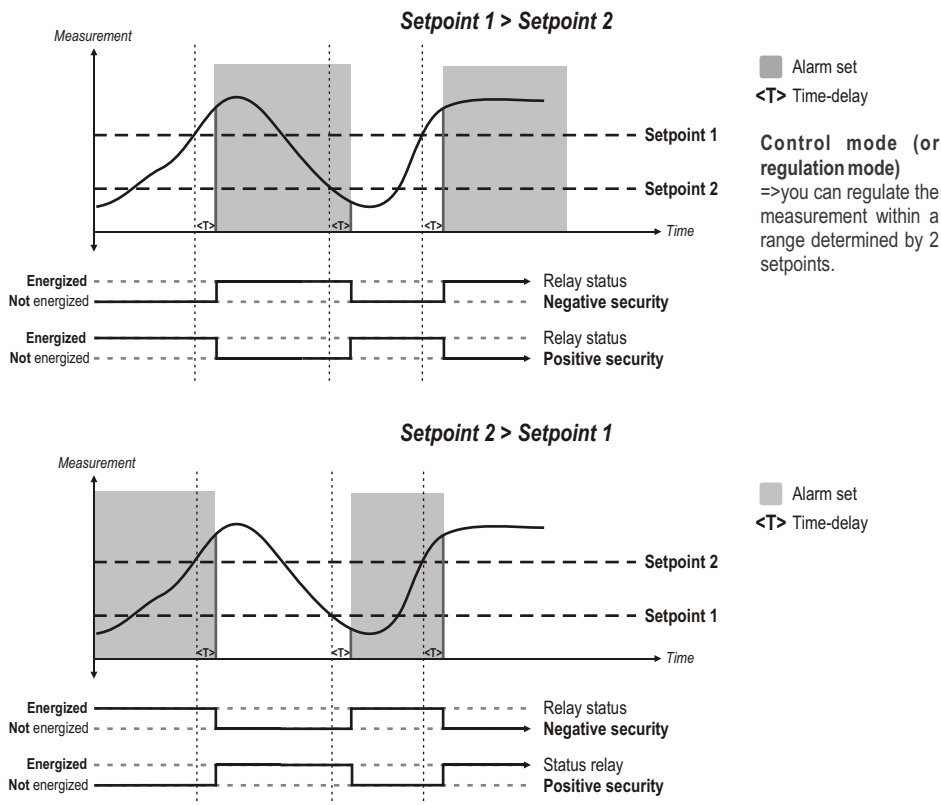



Configuration N°2 : 1 setpoint, time-delay and rising action activated

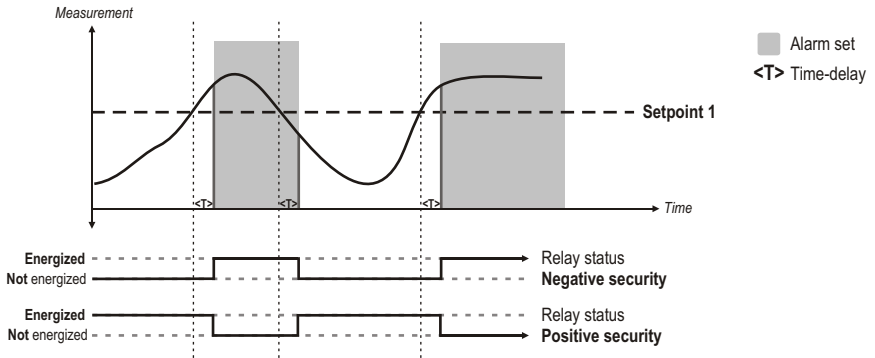

Configuration N°3 : 1 setpoint, time-delay and falling action activated

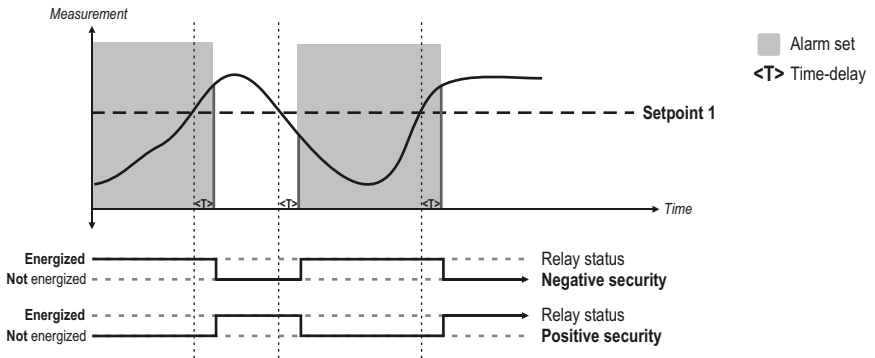

7.f - Alarm mode selection



Go into configuration mode (see page 5). The folder number displayed corresponds to the last configuration folder used.

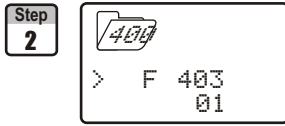

Select the folder "400" and validate with **⊙**.

Select sub-folder

"403"
Alarm 1



"408"
Alarm 2



"413"
Relay 1



"418"
Relay 2



and validate with **⊙**.



With **+** and **-** keys, select the code relative to the alarm mode (see chart below). Validate with **⊙**.

Code	Alarm mode	Drawing
00	No alarm	
01	2 setpoints with time-delay (control mode)	N° 1 page 17
02	1 setpoint with time-delay and rising action	N° 2 page 18
03	1 setpoint with time-delay and falling action	N° 3 page 18



The cursor **>** returns to sub-folders line.

- press twice **Esc** to return to reading mode.
- press once **Esc** to return to another folder selection.
- with **+** and **-** keys, you can choose another sub-folder from the folder 400.

7.g - Setpoints and time-delay setting

7.g.1 - Setpoints



Go into configuration mode (see page 5). The folder number displayed corresponds to the last configuration folder used.

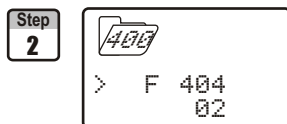

Select the folder "400" and validate with **OK**.

To configure the **setpoint 1**, select sub-folder



and validate with **OK**.

To configure the **setpoint 2** (alarm in **control mode**, see p17), select sub-folder



and validate with **OK**.



With **+** and **-** keys, select the value sign: negative or positive. Validate with **OK**.

Then, enter the setpoint value and validate with **OK**.

! You must enter values according to the units of measurement selected, not according to the measuring range of the transmitter.

*Ex. on a CP 303 pressure transmitter (0 to ±1000 Pa) with a reading in mmH₂O, the minimum and maximum ranges must be configured on measuring range of 0 to ±102 mmH₂O. See **conversion chart on page 13**.*

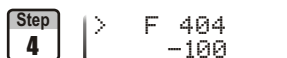

The cursor **>** returns to sub-folders line.

- press twice **Esc** to return to reading mode.
- press once **Esc** to return to another folder selection.
- with **+** and **-** keys, you can choose another sub-folder from the folder 400.

NOTE If after having set up a setpoint, the unit of measurement is modified (see page 9), then you have to reconfigure the setpoints according to this new unit of measurement.

7.g.2 - Time-delay



Go into configuration mode (see page 5). The folder number displayed corresponds to the last configuration folder used.

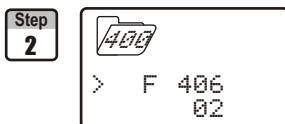

Select the folder "400" and validate with **OK**.

Select sub-folder



and validate with **OK**.

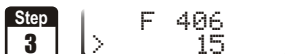

With **+** and **-** keys, set the required time-delay: from 00 to 60 seconds. If you do not need the time-delay, enter 00. Validate with **OK**.



The cursor **>** returns to sub-folders line.

- press twice **Esc** to return to reading mode.
- press once **Esc** to return to another folder selection.
- with **+** and **-** keys, you can choose another sub-folder from the folder 400.



8.a - Pressure measurement integration (CP 300)

The integration coefficient makes an average of the measurements: this helps to avoid any excessive variations and guarantees a stable measurement.

New value displayed = $[(10 - \text{Coef.}) \times N^{\text{th}} \text{ Value}] + (\text{Coef.} \times \text{former value}) / 10$

This value is applicable when the variation is **less than +/- (Coef. x 10 Pa)**

Example : CP303 (0-1000 Pa) - First measurement: 120 Pa - New measurement : 125 Pa

The pressure source is stable, the user applied a low integration. Integration : 1, maximum variation allowed **+/-10 Pa**. Since the variation is less than 10 Pa, we apply the integration calculation formula. Next measurement displayed $((9 \times 125) + (1 \times 120)) / 10 = 124.5$ soit 124 Pa. If the new value had been 131 Pa, the next value displayed would have been 100% of the new value, i.e 131 Pa.

Step 1



Go into configuration mode (see page 5). The folder number displayed corresponds to the last configuration folder used.

Step 2

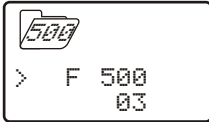

Select the folder "500" and validate with **OK**.

Select the sub-folder "500" and validate with **OK**.

The cursor > returns to available choices.



Step 3

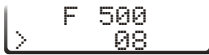

With **+** and **-** keys, you can set the integration value: from 00 to 09.

Validate with **OK**.

Coefficient 0 : no integration, large variation of the measurement displayed.

Coefficient 9 : maximum integration, more stable measurement display.

Step 4

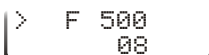

The cursor > returns to sub-folders line.

• press twice **ESC** to return to reading mode.

• press once **ESC** to return to another folder selection.

• with **+** and **-** keys, you can choose another sub-folder from the folder 500.

8.a - Time-delay between 2 self-calibrations

Step 1



Go into configuration mode (see page 5). The folder number displayed corresponds to the last configuration folder used.

Step 2

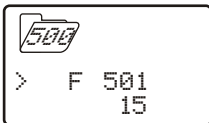

Select the folder "500" and validate with **OK**.

Select the sub-folder "501" and validate with **OK**.

The cursor > goes to available choices.



Step 3



With **+** and **-** keys, you can set the time-delay values between 2 self-calibrations: from 0 to 60 minutes. Validate with **OK**.

Note : if the value is equal to 0, the transmitter will not carry out any self-calibration.

Step 4

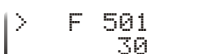

The cursor > returns to sub-folder line.

• press twice **ESC** to return to reading mode.

• press once **ESC** to return to another folder selection.

• with **+** and **-** keys, you can choose another sub-folder from the folder 500



Whenever you want, in reading mode, you can carry out a self-calibration by keeping "ESC" pressed for 5 seconds.

9.a - Offset setting in humidity and temperature

In order to compensate for any longterm drift of the transmitter, you can add an offset to the value displayed by the TH 200 with the EHK 500 reference portable instrument or via the keypad.





 Function only available on humidity transmitters: **TH 300**





The EHK 500 is a reference portable instrument (optional) which enables you to adjust at one point the humidity and temperature reading, via the RS 232 connection cable. Thanks to this new time-saving system, no need to return the transmitter to our factory.

Your transmitter is always available on site. For more details, see technical datasheet and user manual of EHK 500.

9.a.1 - Offset in hygrometry

- Etape 1**  Go into the configuration mode (see page 2). The folder number displayed corresponds to the last folder used.
- Etape 2**  Select folder "500" and validate with **OK**.
Select sub-folder "500" and validate with **OK**.
The cursor > goes to the line of available choices.
- Etape 3**  With keys **+** and **-**, enter the offset value: from -50,0 to +50,0. Validate with **OK**.
- Etape 4**  The cursor > returns to sub-folders line.
• press once on **ESC** to return to reading mode.
• or choose another folder to access other functions.

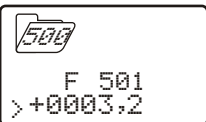
9.a.2 - Offset in temperature

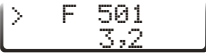
- Etape 1**  Go into the configuration mode (see page 2). The folder number displayed corresponds to the last folder used.
- Etape 2**  Select folder "500" and validate with **OK**.
Select sub-folder "501" for an offset in °C or "502" for an offset in °F and validate with **OK**.
The cursor > goes to the line of available choices.
- Etape 3**  With keys **+** and **-**, enter the offset value: from -50,0 to +50,0 (in °C) or from -90 to +90 (in °F). Validate with **OK**.
- Etape 4**  The cursor > returns to folders line.
• press once on **ESC** to return to reading mode.
• or choose another folder to access other functions.

NOTE If you activate the offset in temperature in °C (function 501), the value entered is automatically converted into °F (function 502) and vice versa.

10.a - Temperature compensation

You can **modify the temperature compensation value**.

The air velocity and airflow measured with a differential probe (such as Pitot tube, Debimo blade, orifice plate...) depends on the working temperature. Then, it is required to enter the **working temperature** to get more accurate results. You can enter the value either manually or using a thermocouple K probe which offers the automatic temperature compensation.



Function only available on pressure transmitter type **CP 300 with SQR option**

10.a.1 - Manual compensation

Step
1



Go into configuration mode (see page 5). The folder number displayed corresponds to the last configuration folder used.

Step
2

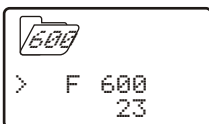

Select the folder "600" and validate with **OK**.

Select the sub-folder "600" to enter a value in °C

or "601" to enter a value in °F



validate with **OK**. The cursor > returns to available choices.

Step
3



With **+** and **-** keys, enter the temperature compensation (Celsius degree shown alongside, sub-folder "600"). Validate with **OK**.

Step
4

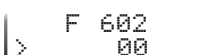

Select the folder "602" and validate with **OK**.

The cursor > returns to available choices.

With **+** and **-** keys, choose **00**. Validate with **OK**.

Step
5

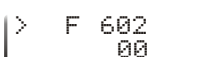

The cursor > returns to sub-folders line.

- press twice **ESC** to return to reading mode.
- press once **ESC** to return to another folder selection.
- with **+** and **-** keys, you can choose another sub-folder from the folder 600

NOTE

If you make a temperature compensation in Celsius degree (sub-folder "600"), the transmitter will automatically make the conversion into Fahrenheit degree (sub-folder "601") and vice versa.

10.a.1 - Automatic compensation



Before configuring the automatic compensation in temperature, **you must connect** the thermocouple K probe on the transmitter.

Step 1



Go into configuration mode (see page 5). The folder number displayed corresponds to the last configuration folder used.

Step 2

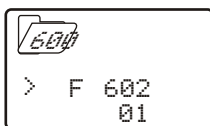

Select the folder "600" and validate with **OK**.

Select the sub-folder "602", validate with **OK**.

The cursor > returns to available choices.



Step 3

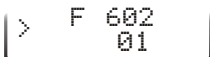

With **+** and **-** keys, choose 01. Validate with **OK**.

Step 4

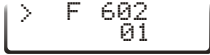

The cursor > returns to sub-folders line.

- press twice **Esc** to return to reading mode.

- press once **Esc** to return to another folder selection.

- with **+** and **-** keys, you can choose another sub-folder from the folder 500

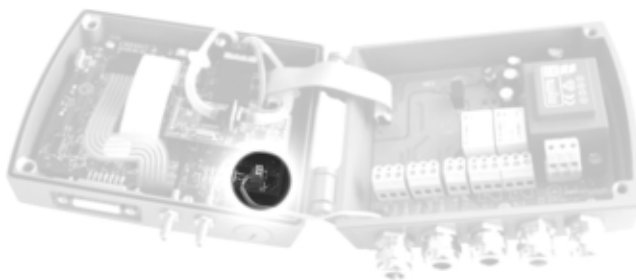

Once the automatic temperature compensation configuration is complete, **check carefully the connection** of the thermocouple K probe.

10.b - Air velocity coefficient selection (CP 300)

Since the air velocity is calculated from the pressure (on a CP 300) and from a differential probe, **you must enter the coefficient value of the differential probe.** For Pitot tubes and Debimo blades, the coefficient is already included in the transmitter.



Function only available on the pressure transmitters: **CP 300 + SQR option**

Step 1



Go into configuration mode (see page 5). The folder number displayed corresponds to the last configuration folder used.

Step 2

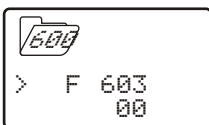

Select the folder "600" and validate with **OK**.

Select the sub-folder "603" and validate with **OK**.
The cursor > goes to available choices.



Step 3

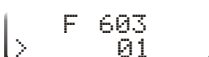

With **+** and **-** keys, select the differential probe type. Validate with **OK**.

Code	Differential probe	Coef.
00	Pitot tube L (ISO 3966)	1
01	DEBIMO blade	0.8165
02	Other differential probe	To be entered

Step 4

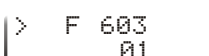

The cursor > returns to sub-folders line.

- press twice **ESC** to return to reading mode.
- press once **ESC** to return to another folder selection.
- with **+** and **-** keys, you can choose another sub-folder from the folder 600.



If you use "Other differential probe" please carefully follow the instructions below.

10.b.1 - Manual coefficient input

Step 1

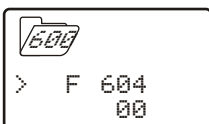

Select the folder "600" and validate with **OK**.

Select the sub-folder "604" and validate with **OK**.
The cursor > goes to available choices.



Step 2



With **+** and **-** keys, **enter the coefficient relative to your differential probe.** This coefficient is given by the manufacturer (from 0.0001 to 9.9999).
Validate with **OK**.

Step 3

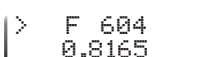

The cursor > returns to sub-folders line.

- press twice **ESC** to return to reading mode.
- press once **ESC** to return to another folder selection.
- with **+** and **-** keys, you can choose another sub-folder from the folder 600.

10.c- Air velocity coefficient input

With this correction coefficient, you can adjust the transmitter according to the air velocity in your installation.



Function only available on the transmitter : CP 300 + SQR option

10.c.1 - How to calculate it ?

If the air velocity in your duct is equal to **17 m/s**, and if the transmitter indicates **16.6 m/s**, then the coefficient to apply is $17/16,6$, ie **1.024**

10.c.2 - Coefficient input

Step
1



Go into configuration mode (see page 5). The folder number displayed corresponds to the last configuration folder used.

Step
2

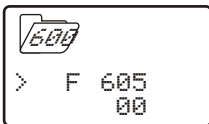

Select the folder "600" and validate with **OK**.

Select the sub-folder "605" and validate with **OK**.
The cursor > goes to available choices.



Step
3



With **+** and **-** keys, **enter the coefficient value** calculated (from 0.200 to 2.000). Validate with **OK**.

Step
4

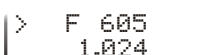

The cursor > returns to the sub-folders line.

- press twice **Esc** to return to reading mode.
- press once **Esc** to return to another folder selection.
- with **+** et **-** keys, you can choose another sub-folder from the folder 600.

11.a - Selection of duct section type or airflow coefficient

11.a.1 - Working from the section type

Function only available on pressure transmitters: CP 300 + SQR option



Go into configuration mode (see page 5). The folder number displayed corresponds to the last configuration folder used.

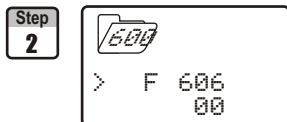

Select the folder "600" and validate with . Select the sub-folder "606" and validate with . The cursor > goes to available choices.



With and keys, select the section type (00 or 01). Validate with .

Code	Section type
00	Rectangular
01	Circular
02	Airflow coefficient (to be entered, see p 29)



The cursor > returns to sub-folders line.

- press twice to return to reading mode.
- press once to return to another folder selection.
- with and keys to choose another sub-folder from the folder 600.

Section sizes input



Go into configuration mode (see page 5). The folder number displayed corresponds to the last configuration folder used.

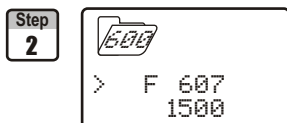

Select the folder "600" and validate with .

Select sub-folder

	Rectangular section		Circular section
	Length	Width	Diameter
mm	"607"	"608"	"609"
inch	"610"	"611"	"612"

and validate with .



With \oplus and \ominus keys, enter the value (from 0 to 3000mm or 0 to 118.11 inch).
Validate with OK .

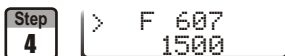

The cursor $>$ returns to sub-folders line.

- press twice Esc to return to reading mode.
- press once Esc to return to another folder selection.
- with \oplus and \ominus keys, you can choose another sub-folder from the folder 600.

NOTE If you enter a length, width or diameter in mm, the transmitter will automatically calculate the conversion in Inch (vice versa)

10.a.2 - Working from a airflow coefficient

With this coefficient, you can calculate the airflow from the pressure. This coefficient is given by the manufacturer of the devices supplied with pressure connections (+ and -). From the square root of the pressure measured (Delta P), and from this coefficient, you get the airflow.

$$\text{Airflow} = C_D \times \sqrt{\Delta \text{Pressure}}$$

! Function only available for the pressure transmitter: **CP 300 + SQR option**. In this calculation mode, you have **no access to reading of air velocity**. If you activate this calculation mode and also a channel in air velocity, the transmitter will display an error code "4".

! **Go back to procedure page 28 / step 3:**
With \oplus and \ominus keys, select 02 and validate with OK .



Go into configuration mode (see page 5). The folder number displayed corresponds to the last configuration folder used.

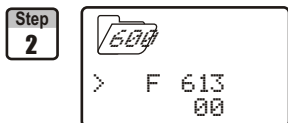

Select the folder "600" and validate with OK .
Select the sub-folder "613" and validate with OK .
The cursor $>$ goes to available choices.



With \oplus and \ominus keys, enter the airflow coefficient value (from 0,01 to 999,99).
Validate with OK .



The cursor $>$ returns to sub-folders line.
Select the sub-folder "614" to select the **unit of measurement in pressure** for the airflow calculation and validate with OK .
The cursor $>$ returns to available choices.





With \oplus and \ominus keys, select the unit of measurement (see chart below).
Validate with OK .

	CP301/302/303	CP304
01	Pa	Pa
02	mmH ₂ O	mmH ₂ O
03	inWg	inWg
04	mbar	mbar
05	-	mmHg



The cursor > returns to sub-folders line.

- press twice Esc to return to reading mode.
- press once Esc to return to another folder selection.
- with \oplus and \ominus keys to choose another sub-folder from the folder 600.



12.a- Activation / deactivation of the RS232 and home bus

Class 300 transmitters have one RS232 and one RS 485 digital output (Modbus protocol) - optional. With the RS 232, you can display 1 or 2 parameters which are measured by other Class 200 and 300 transmitters, or you can send measurements to be displayed on another Class 300 transmitters.

! If you set up your transmitter to send measurements to another transmitter via RS 232, then you will not be able to use the RS 485 digital output anymore (Modbus - optional).



Go into configuration mode (see page 5). The folder number displayed corresponds to the last configuration folder used.

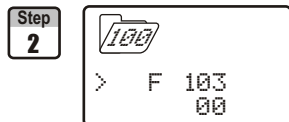

Select the folder "100" and validate with **OK**.
Select the sub-folder "103" and validate with **OK**.



With **+** and **-** keys, select **00** to receive data from another transmitter or select **01** to send data via RS 232. Validate with **OK**.
CAUTION !!

When the transmitter is configured to **receive data**, then the RS 485 Modbus is **active**. When the transmitter is configured to **send data** via RS 232, then the RS 485 Modbus is **inactive**.



The cursor **>** returns to sub-folders line.
• press twice **Esc** to return to reading mode.
• press once **Esc** to return to another folder selection.
• with **+** and **-** keys, you can choose another sub-folder from the folder 100.



12.b- Serial number display



Go into configuration mode (see page 5). The folder number displayed corresponds to the last configuration folder used.

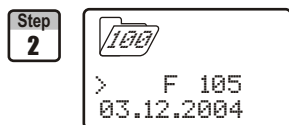

Select the folder "100" and validate with **OK**.
Select the sub-folder "105"

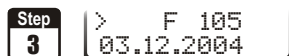

The serial number of the transmitter is displayed. The cursor **>** returns to sub-folders line.
• press twice **Esc** to return to reading mode.
• press once **Esc** to return to another folder selection.
• with **+** and **-** keys to choose another sub-folder from the folder 100.



12.c- Modification of Modbus communication speed

Step 1



Go into configuration mode (see page 5). The folder number displayed corresponds to the last configuration folder used.

Step 2

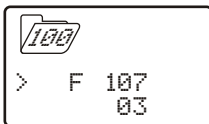

Select the folder "100" and validate with **OK**.

Select the sub-folder "107" and validate with **OK**.

Step 3

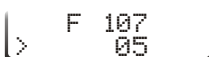

With **+** and **-** keys, select a communication speed (see chart below). Validate with **OK**.



00	2400 bauds	03	19200 bauds (speed by default)
01	4800 bauds	04	38400 bauds
02	9600 bauds	05	115200 bauds

Step 4

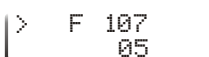

The cursor > returns to sub-folders line.

- press twice **Esc** to return to reading mode.
- press once **Esc** to return to another folder selection.
- with **+** and **-** keys, you can choose another sub-folder from the folder 100.



12.d- Purge mode

The purge mode enables to freeze the measurement when being displayed, enables to lock the analogue outputs, and to activate the relay 1, in order to actuate a de-dust system of a air movement conditions.



This function is only available on **CP300** pressure transmitters.

12.d.1-Activation / deactivation of Purge Mode

Step 1



Go into configuration mode (see page 5). The folder number displayed corresponds to the last configuration folder used.

Step 2

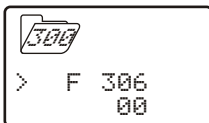

Select the folder "300" and validate with **OK**.

Select the sub-folder "306" and validate with **OK**.

Step 3

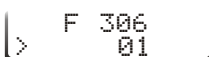

With **+** and **-** keys, activate (**01**) or deactivate (**00**) the purge mode. Validate with **OK**.



Step 4

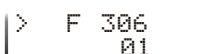

The cursor **>** returns to sub-folders line.

- press twice **Esc** to return to reading mode.
- press once **Esc** to return to another folder selection.
- with **+** and **-** keys, choose another sub-folder from the folder 300

12.d.2-Working duration of purge mode

Step 1



Go into configuration mode (see page 5). The folder number displayed corresponds to the last configuration folder displayed.

Step 2

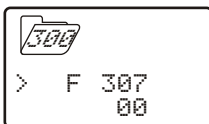

Select the folder "300" and validate with **OK**.

Select the sub-folder "307" and validate with **OK**.

Step 3

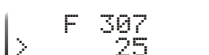

With **+** and **-** keys, enter the value in seconds of the required working duration of each purge (from **01** to **60**). Validate with **OK**.



Step 4

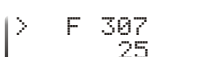

The cursor **>** returns to sub-folders line.

- press twice **Esc** to return to reading mode.
- press once **Esc** to return to another folder selection.
- press **+** and **-** to choose another sub-folder from the folder 300



12.d- Mode Purge

12.d.3 -Frequency

Step 1



Go into configuration mode (see page 5). The folder number displayed corresponds to the last configuration folder used.

Step 2

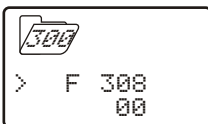

Select the folder "300" and validate with **OK**.
Select the sub-folder "308" and validate with **OK**.

Step 3

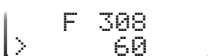

With keys **+** and **-**, enter the value in minutes of the frequency of each purge (from 01 to 9999). Validate with **OK**.



Step 4

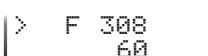

The cursor **>** returns to sub-folders line.
• press twice **ESC** to return to reading mode.
• press once **ESC** to return to another folder selection.
• with **+** and **-**, choose another sub-folder from the folder 300.

12.d.4 - Time-delay

Once the purge is finished, time-delay is a time period before the transmitter returns to measurement mode and before the analogue outputs are reactivated.

Step 1



Go into configuration mode (see page 5). The folder number displayed corresponds to the last configuration folder used.

Step 2

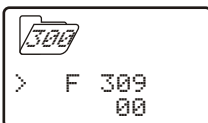

Select the folder "300" and validate with **OK**.
Select the sub-folder "309" and validate with **OK**.

Step 3

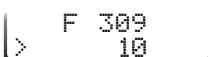

With **+** and **-** keys, enter the value in seconds of the time-delay required (from 00 to 60). Validate with **OK**.



Step 4

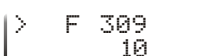

The cursor **>** returns to the sub-folders line.
• press twice **ESC** to return to reading mode.
• press once **ESC** to return to another folder selection.
• with **+** and **-** keys, choose another sub-folder from the folder 300.



Code	Problem	Solution
01	Configuration error (alarm(s) set on a non displayed/activated channel)	<ul style="list-style-type: none">• Check status of the 4 alarms and 4 channels. Ex. : the error appears if an alarm is configured on a channel (1,2,3 or 4) which is not active. Then, you must activate the channel on which you want to configure an alarm. Activation of a channel : see page 5 Alarm and relay configurations : see page 14
02	No channel activated	<ul style="list-style-type: none">• Activate one channel (at least). Activation of a channel : see page 5
03	Humidity probe (TH300) or SPI (CP 300) not connected	<ul style="list-style-type: none">• Connect the probe / SPI (see user manual SPI)
04	Only on CP 300. A channel is configured in air velocity (see page 5) and the airflow calculation function (page 23) is set to 02 (airflow coefficient). This combination is impossible .	<ul style="list-style-type: none">• Select a unit in airflow for the channel 1, 2, 3 or 4 (see channels configuration, page 5)• Instead of airflow coefficient, select a circular or rectangular section in function 606 (see page 28)



F 100

Code		Description	Available settings												
100	200	Channel n° for IR remote control	0 to 9												
101	202	Backlight	0 or 1												
102	204	Display contrast control	from 0 to 10												
103	206	Sending data via RS232	0 or 1												
104	208	Keypad locking	0 or 1												
105	210	Serial number display													
106	212	Modbus slave number	1 to 32												
107	214	Modbus communication speed	<table border="1"> <tbody> <tr> <td>00</td> <td>2400 bds</td> <td>02</td> <td>9600 bds</td> <td>04</td> <td>38400 bds</td> </tr> <tr> <td>01</td> <td>4800 bds</td> <td>03</td> <td>19200 bds</td> <td>05</td> <td>115200 bds</td> </tr> </tbody> </table>	00	2400 bds	02	9600 bds	04	38400 bds	01	4800 bds	03	19200 bds	05	115200 bds
00	2400 bds	02	9600 bds	04	38400 bds										
01	4800 bds	03	19200 bds	05	115200 bds										

F 200

Code		Description
200	400	Unit of channel 1
201	402	Unit of channel 2
202	404	Unit of channel 3
203	406	Unit of channel 4

Available settings

	CP301, 302 et 303	CP 304	TH300
00	Inactive channel	Inactive channel	Inactive channel
01	Pa	Pa	°C
02	mmH ₂ O	mmH ₂ O	°F
03	inWg	inWg	%HR
04	mbar	mbar	g/Kg (absolute humid. p)
05	°C	mmHg	°C (dew temperature Td)
06	°F	°C	°F (dew temperature Td)
07	m/s	°F	°C (wet temperature Tw)
08	fpm	m/s	°F (wet temperature Tw)
09	m ³ /h	fpm	KJ/Kg (Enthalpy i)
10	L/s	m ³ /h	
11	cfm	L/s	
12	m ³ /s	cfm	
13		m ³ /s	



F300

channel 1

Code



Description

Available settings

300

600

Analogue output setting on channel 1

0=>0V, 1=>5V, 2=>10V

3=>4mA, 4=>12mA, 5=>20mA

301

602

Analogue output minimum on channel 1

302

604

Analogue output maximum on channel 1

channel 2

303

606

Analogue output setting on channel 1

0=>0V, 1=>5V, 2=>10V

3=>4mA, 4=>12mA, 5=>20mA

304

608

Analogue output minimum on channel 2

305

610

Analogue output maximum on channel 2

CP 300

306

612

Activation / Deactivation of purge mode

00 or 01

307

614

Working time of each purge

from 01 to 60 seconds

308

616

Frequency of each purge

from 01 to 9999 minutes

309

618

Time-delay after purge

from 00 to 60 seconds



F400

ALARM 1

Code	 Description	Available settings
400	800 Audible alarm	0 or 1
401	802 Relays security	0 (negative) or 1 (positive)
402	804 Channel selection for alarm 1	1=> channel 1, 2=> channel 2, 3=>channel 3, 4=> channel 4
403	806 Channel selection for alarm 1	0=> inactive 1=> setpoint 1, setpoint 2 and time-delay 2=> setpoint 1, time-delay and rising action 3=> setpoint 1, time-delay and falling action
404	808 Setpoint 1 of alarm 1	
405	810 Setpoint 2 of alarm 1	
406	812 Time-delay on alarm 1	from 0 to 60 seconds

ALARM 2

407	814 Channel selection for alarm 2	1=> channel 1, 2=> channel 2, 3=>channel 3, 4=> channel 4
408	816 Alarm 2 type selection	0=> inactive 1=> setpoint 1, setpoint 2 and time-delay 2=> setpoint 1, time-delay and rising action 3=> setpoint 1, time-delay, and falling action
409	818 Setpoint 1 of alarm 2	
410	820 Setpoint 2 of alarm 2	
411	822 Time-delay on alarm 2	from 0 to 60 seconds

RELAY 1

412	824 Channel selection for Relay 1	1=> channel 1, 2=> channel 2, 3=>channel 3, 4=> channel 4
413	826 Alarm type selection for Relay 1	0=> inactive 1=> setpoint 1, setpoint 2 and time-delay 2=> setpoint 1, time-delay and rising action 3=> setpoint 1, time-delay and falling action
414	828 Setpoint 1 of Relay 1	
415	830 Setpoint 2 of Relay 1	
416	832 Time-delay of Relay 1	from 0 to 60 seconds

RELAY 2

417	834 Channel selection for Relay 2	1=> channel 1, 2=> channel 2, 3=>channel 3, 4=> channel 4
418	836 Alarm type selection for Relay 1	0=> inactive 1=> setpoint 1, setpoint 2 and time-delay 2=> setpoint 1, time-delay and rising action 3=> setpoint 1, time-delay and falling action
419	838 Setpoint 1 of Relay 2	
420	840 Setpoint 2 of Relay 2	
421	842 Time-delay of Relay 2	from 0 to 60 seconds



14. Functions recap

F500

Code		Model	Description	Available settings
500	1000	CP300	Measurement integration	from 0 to 9
500	1000	TH300	Offset in humidity	-50,0 to +50,0
501	1002	CP300	Self-calibration for time-delay	from 0 to 60 minutes
501	1002	TH200	Offset in temperature (°C)	from -50,0 to +50,0
502	1004	TH200	Offset in temperature (°F)	from -90,0 to +90,0

F600

Code		Description	Available settings																		
600	1200	Compensation temperature in °C	-																		
601	1202	Compensation temperature in °F	-																		
602	1204	Compensation type	manual =>00 or automatic=>01																		
603	1206	Air velocity measurement mean	<table border="1"> <thead> <tr> <th>Code</th> <th>Differential probe</th> </tr> </thead> <tbody> <tr> <td>00</td> <td>Pitot tube</td> </tr> <tr> <td>01</td> <td>DEBIMO blade</td> </tr> <tr> <td>02</td> <td>Other differential probe</td> </tr> </tbody> </table>	Code	Differential probe	00	Pitot tube	01	DEBIMO blade	02	Other differential probe										
Code	Differential probe																				
00	Pitot tube																				
01	DEBIMO blade																				
02	Other differential probe																				
604	1208	Air velocity coefficient value	from 0.0001 to 9.9999																		
605	1210	Air velocity correction coefficient	from 0.200 to 2.000																		
606	1212	Section type selection	<table border="1"> <thead> <tr> <th>Code</th> <th>Section type</th> </tr> </thead> <tbody> <tr> <td>00</td> <td>Rectangular</td> </tr> <tr> <td>01</td> <td>Circular</td> </tr> <tr> <td>02</td> <td>Airflow coefficient</td> </tr> </tbody> </table>	Code	Section type	00	Rectangular	01	Circular	02	Airflow coefficient										
Code	Section type																				
00	Rectangular																				
01	Circular																				
02	Airflow coefficient																				
607	1214	Section length in mm	from 0 to 3000 mm																		
608	1216	Section width in mm	from 0 to 3000 mm																		
609	1218	Section diameter in mm	from 0 to 3000 mm																		
610	1220	Section length in inch	from 0 to 118.11 inch																		
611	1222	Section width in inch	from 0 to 118.11 inch																		
612	1224	Section diameter in inch	from 0 to 118.11 inch																		
613	1226	Airflow coefficient	from 0.01 to 999.99																		
614	1228	Units of pressure for the pressure calculation	<table border="1"> <thead> <tr> <th></th> <th>CP301/302/303</th> <th>CP304</th> </tr> </thead> <tbody> <tr> <td>01</td> <td>Pa</td> <td>Pa</td> </tr> <tr> <td>02</td> <td>mmH₂O</td> <td>mmH₂O</td> </tr> <tr> <td>03</td> <td>inWg</td> <td>inWg</td> </tr> <tr> <td>04</td> <td>mbar</td> <td>mbar</td> </tr> <tr> <td>05</td> <td>-</td> <td>mmHg</td> </tr> </tbody> </table>		CP301/302/303	CP304	01	Pa	Pa	02	mmH ₂ O	mmH ₂ O	03	inWg	inWg	04	mbar	mbar	05	-	mmHg
	CP301/302/303	CP304																			
01	Pa	Pa																			
02	mmH ₂ O	mmH ₂ O																			
03	inWg	inWg																			
04	mbar	mbar																			
05	-	mmHg																			

CP 300

CP 300

Ref. NT Ang - Classe 300 - 05/05B - We reserve the right to modify the characteristics of our products without notice.

www.kimo.fr

EXPORT DEPART MENT

Boulevard de Beaubourg

Emerainville - BP 48

77312 MARNELA VALLEE CEDEX 2

Tel : + 33.1.60.06.69.25

Fax : + 33.1.60.06.69.29

